

## TYPE

### GENERAL FEATURES

|                            |   |
|----------------------------|---|
| <b>APPLICATIONS</b>        | Indirect Lighting   |
| <b>LENS</b>                | Clear   |
| <b>LENGTH</b>              | Built to Order (+/- .25" Tolerance)   |
| <b>CONSTRUCTION</b>        | Aluminum Extrusion  |
| <b>FINISH</b>              | White   |
| <b>WEIGHT</b>              | 4.50 lbs per foot   |
| <b>MOUNTING</b>            | Mounting Brackets or Aircraft Cable (Sold Separately)   |
| <b>LISTING</b>             | Dry or Damp Location<br>UL1598, CSA C22.2#250.0<br>UL8750, CSA250<br>UL2108, 67.1.9, 60.4, CSA C22.2 #9 |
| <b>DRIVER</b>              | Driver on Board or Remote Driver  |
| <b>CLOSET RATING</b>       | Up to 3.6 Watts per Foot Maximum  |
| <b>TEMPERATURE RATINGS</b> | Operating / Startup: -20° to 48°C (-4° to 120°F)<br>Storage: -40° to 76°C (-40° to 170°F)               |
| <b>FG INSTALLATION</b>     | <a href="#">Link to Installation Instructions</a>   |
| <b>TB INSTALLATION</b>     | <a href="#">Link to Installation Instructions</a>   |
| <b>HC INSTALLATION</b>     | <a href="#">Link to Installation Instructions</a>   |
| <b>MI INSTALLATION</b>     | <a href="#">Link to Installation Instructions</a>   |

### END VIEWS / DIMENSIONS

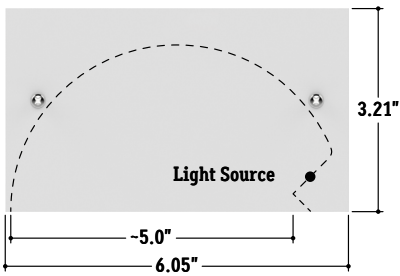

**Note:** End view dimensions do not include ceiling trims or mounting options. Refer to trim-specific installation instructions for additional details.

### MOUNTING OPTIONS

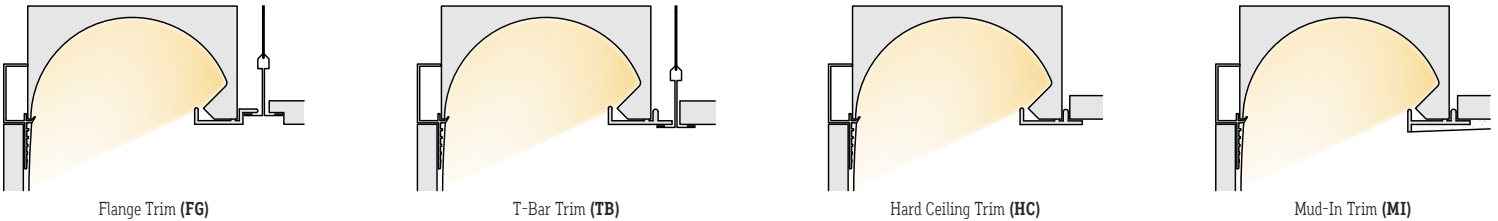

### SPECIFY PRODUCT CODE | CHOOSE FROM DROP DOWNS

| SERIES                                     | CCT GAMUT   |             | WATTS PER FOOT                   | CONTROL INTERFACE          | LISTING           | LUMINAIRE VOLTAGE                          | LUMINAIRE LENGTH                                 |
|--|-------------|-------------|----------------------------------|----------------------------|-------------------|--|--|
|  | LOW CCT     | HIGH CCT    |                                  |                            |                   |  |  |
| <b>UNV</b>                                 |             |             |                                  |                            |                   |  |  |
| Flange Ceiling Trim<br>(ALS500T-RMW-CT-FG) | 2000K (20K) | 3000K (30K) | 1.5 Watts (1.5W) 124 Lumens/ft*1 | DALI*2<br>(DALI)           | Indoor<br>(DRY)   | 120 - 277 Volts<br>Line Voltage*4<br>(UNV) | Specify Length in Feet & Inches<br>Example: 7'8" |
|  | 2200K (22K) | 3500K (35K) | 2 Watts (2W) 166 Lumens/ft*1     |                            |                   |  |  |
| T-Bar Ceiling Trim<br>(ALS500T-RMW-CT-TB)  | 2400K (24K) | 4000K (40K) | 3 Watts (3W) 249 Lumens/ft*1     | 0-10V; 100% - .1%<br>(10V) | Outdoor<br>(DAMP) |  |  |
|  | 2700K (27K) | 4500K (45K) | 4 Watts (4W) 332 Lumens/ft*1     |                            |                   |  |  |
| Hard Ceiling Trim<br>(ALS500T-RMW-CT-HC)   | 5000K (50K) |             | 5 Watts (5W) 415 Lumens/ft*1     | DMX-512*3<br>(DMX)         |                   |  |  |
|  | 5500K (55K) |             | 6 Watts (6W) 498 Lumens/ft*1     |                            |                   |  |  |
| Mud-In Ceiling Trim<br>(ALS500T-RMW-CT-MI) | 6000K (60K) |             | 7 Watts (7W) 581 Lumens/ft*1     |                            |                   |  |  |
|  | 6500K (65K) |             |                                  |                            |                   |  |  |

\*1 Lumens per Foot based on 35K CCT LED. **Example:** 83 Lumens x 1.5 Watts = 124 Lumens per Foot.

\*2 DALI commissioning to be performed by a third party at time of installation. CALI does not provide DALI commissioning.

\*3 Default DMX address of each fixture is 001. Consult third party DMX commissioner to modify at time of installation.

\*4 Remote drivers wattage sized based on length of run. **Example:** 10' run x 6 watts per foot = 60 watts. Driver will be sized to 60 watts maximum.

## ELECTRICAL

|   |  |
|---|--|
| <b>DIMMING</b>                            | 0-10V, DMX, DALI (Type 6)  |
| <b>MAXIMUM RUN (Class 2 Applications)</b> | 36' (1.5W, 2W), 28' (3W), 21' (4W), 17' (5W), 14' (6W), 12' (7W) |
| <b>LUMINAIRE VOLTAGE</b>                  | 120V - 277V (UNV)  |

## COMPATIBLE CONTROL INTERFACES

- 0-10V
- DALI2
- DMX
- Acuity Controls / nLight
- eldoLED
- Distech Controls
- Legrand
- Wattstopper
- Pass & Seymour
- Leviton
- Crestron / Cresnet / SolarSync
- Eaton
- Tridonic / Bluetooth

## LAMP FEATURES

|                  |  |
|------------------|--|
| <b>LAMP TYPE</b> | High Output LEDs (No Mercury)  |
| <b>CRI</b>       | > 91   |
| <b>EFFICACY</b>  | 83 Lumens per Watt (Based on 35K CCT LED)<br>95 Lumens per Watt (Based on 65K CCT LED) |

**Note:** Lumens per Watt based on highest tested CCT value of each gamut. Refer to Photometry data for additional information.

## LAMP SPECIFICATIONS

| GAMUT RANGE      | DESCRIPTION                             | L70 LED LIFE |
|------------------|---|--------------|
| <b>20K - 35K</b> | Color Tuning: 2000 Kelvin - 3500 Kelvin | 60,000 hours |
| <b>27K - 65K</b> | Color Tuning: 2700 Kelvin - 6500 Kelvin |              |

## COLOR TUNING CONTROLS (Sold Separately)

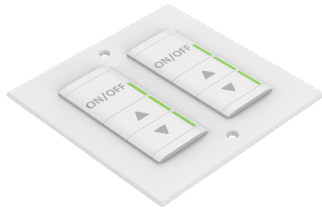

10V Control Switch  
(CTRL-CT-10V)

| PART #      | QTY. |
|-------------|------|
| CTRL-CT-10V |      |

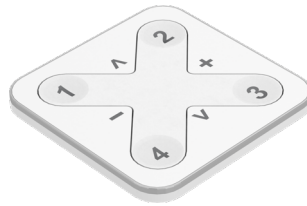

Bluetooth Wireless Control Panel  
(CTRL-CT-BT)

| PART #     | QTY. |
|------------|------|
| CTRL-CT-BT |      |



DMX Touch Panel  
(CTRL-CT-DMX)

| PART #      | QTY. |
|-------------|------|
| CTRL-CT-DMX |      |



DALI Touch Panel  
(CTRL-CT-DALI)

| PART #       | QTY. |
|--------------|------|
| CTRL-CT-DALI |      |

## TRIM STYLE

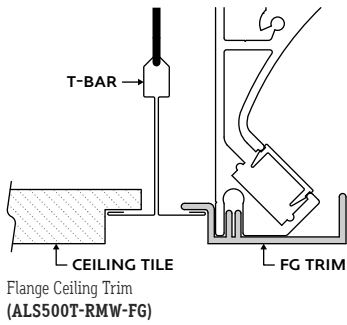

## DESCRIPTION

- Compatible with T-Bar ceiling grid systems
- Best used with tegular-edged tiles
- Trim rests on T-Bar grid

## FINISHED APPEARANCE

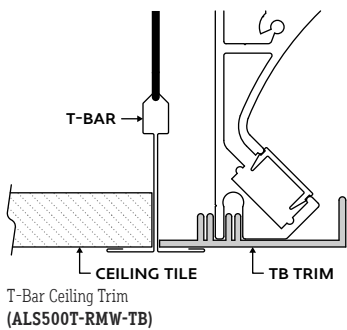

- Compatible with T-Bar ceiling grid systems
- Best used with square-edged tiles
- Trim rests on T-Bar grid

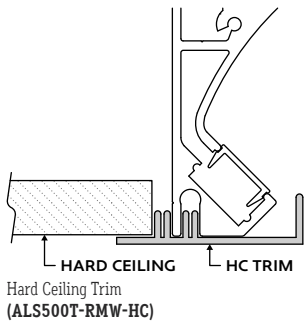
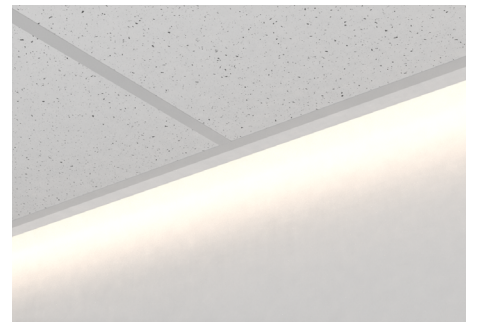

- Compatible suspended hard ceiling systems
- Best used with drywall ceiling
- Trim is flush with ceiling surface

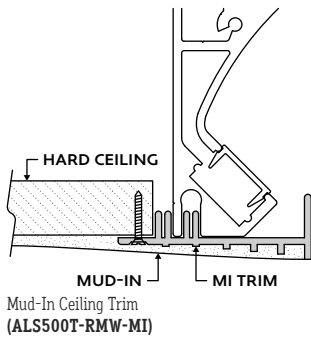
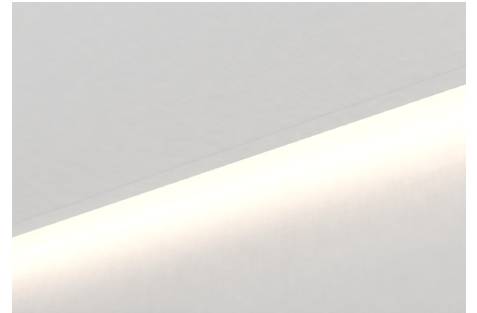

- Compatible suspended hard ceiling systems
- Best used with drywall ceiling
- Mud-in finish for seamless appearance

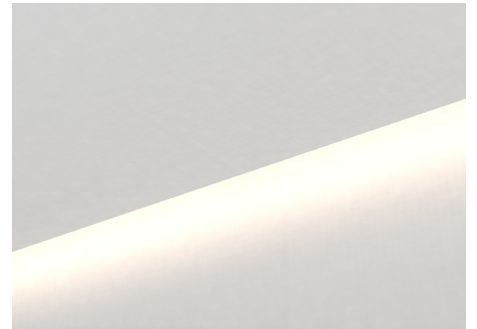

## MOUNTING ACCESSORIES (Sold Separately)

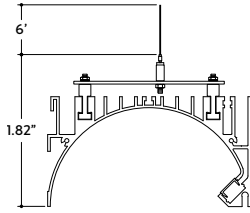
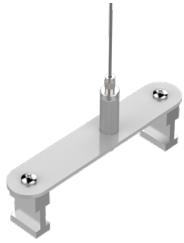

Aircraft Cable Assembly  
(ALS500T-RMW-AC-6')

| PART #            | QTY. |
|-------------------|------|
| ALS500T-RMW-AC-6' |      |

**Note:** Use 3 Aircraft Cable Assemblies per 8', rounded up. Consult factory for custom cable lengths.

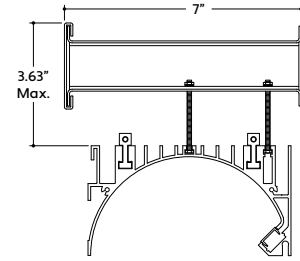
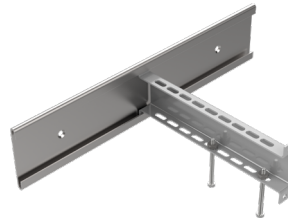

Hanging Bracket Assembly  
(ALS500T-RMW-HB)

| PART #         | QTY. |
|----------------|------|
| ALS500T-RMW-HB |      |

**Note:** Use 3 Hanging Bracket Assemblies per 8', rounded up. Refer to Installation Instructions for additional information.

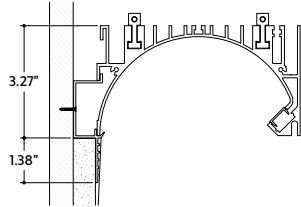
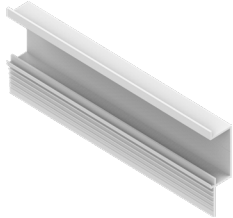

8' Wall Trim Assembly  
(ALS500T-RMW-WT-8')

| PART #            | QTY. |
|-------------------|------|
| ALS500T-RMW-WT-8' |      |

**Note:** Wall Trim is included with fixture in 8' segments for field cutting. Refer to installation instructions for additional info.



Standard End Cap  
(ALS500T-RMW-EC)

| PART #         | QTY. |
|----------------|------|
| ALS500T-RMW-EC |      |



Additional Reflective Film  
(A2-ZELO-ARC-RF-X)  
X = Specify Length Below

| PART #             | QTY. |
|--------------------|------|
| ALS500T-RMW-RF-25' |      |
| ALS500T-RMW-RF-25' |      |
| ALS500T-RMW-RF-25' |      |
| ALS500T-RMW-RF-25' |      |
| ALS500T-RMW-RF-25' |      |
| ALS500T-RMW-RF-25' |      |
| ALS500T-RMW-RF-25' |      |

**Note:** Reflective Film is included with each run length. Use this accessory to order additional film if needed.

## MOUNTING ACCESSORIES (Sold Separately)

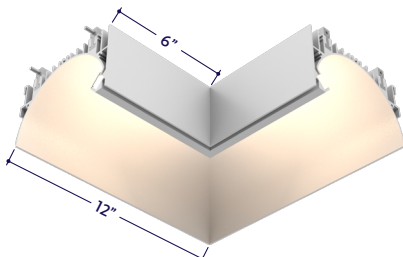

Illuminated 90° Internal Corner  
(ALS500T-RMW-CT-90D-IN)

| PART #                | QTY. |
|-----------------------|------|
| ALS500T-RMW-CT-90D-IN |      |

**Note:** Luminaire specification options of illuminated corners will be matched to the runs.

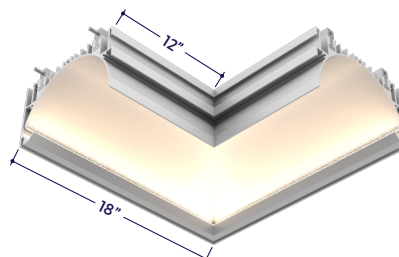

Illuminated 90° External Corner  
(ALS500T-RMW-CT-90D-EX)

| PART #                | QTY. |
|-----------------------|------|
| ALS500T-RMW-CT-90D-EX |      |

**Note:** Luminaire specification options of illuminated corners will be matched to the runs.

## DESIGN GUIDELINES

### Individual Run

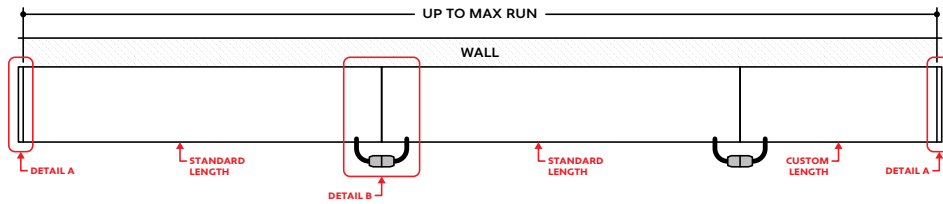

### Run with Mitered Corners

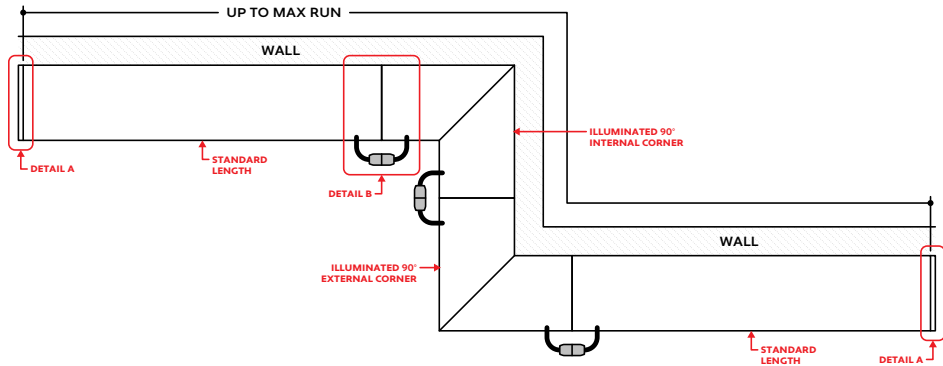

### Run with Jumper Cables

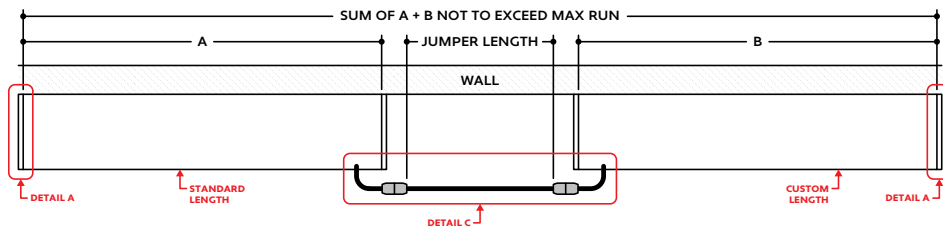

### Continuous Run Exceeding Maximum Run

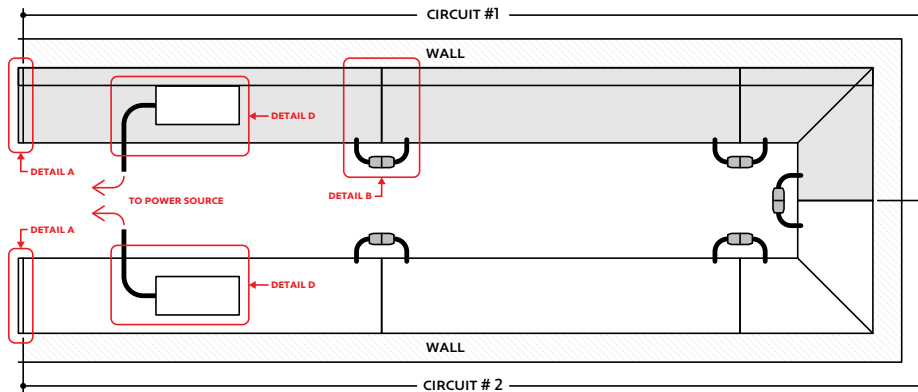

## KEY

- DETAIL A** **End Cap:** An end cap is used to terminate each run at either end.
- DETAIL B** **Continuous Connection:** Luminaire segments are connected using an included continuous connector. See installation instructions for details.
- DETAIL C** **Continuous Connector (Jumper):** Used to span a corner or traverse a gap, corner, or obstacle in the installation area.
- DETAIL D** **Remote Driver:** For T-Bar ceiling grid applications, the driver may be mounted on top of the luminaire. See installation instructions for details.

**Note:** Drawings not to scale. Product may differ from examples shown.

### CALIFORNIA ACCENT LIGHTING, INC.

2820 E. Gretta Lane, Anaheim, CA 92806  
 ph. 800.921.CALI (2254) | fx. 714.535.7902 | info@calilighting.com | calilighting.com  
 © CALI. All rights reserved. CALI reserves the right to make changes or withdraw specifications without prior notice.

**alumLEDs**<sup>TM</sup>  
 Manufactured in the U.S.A.