

## END VIEWS / DIMENSIONS

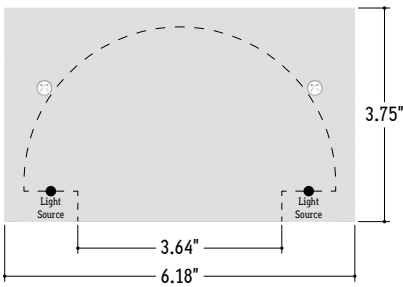

**Note:** End View dimensions do not include ceiling trims or mounting options. Refer to trim-specific installation instructions for additional details.

## GENERAL FEATURES

<b>APPLICATIONS</b>	Indirect Lighting
<b>LENS</b>	Clear
<b>LENGTH</b>	Built to Order ( $\pm 0.25"$ Tolerance)
<b>CONSTRUCTION</b>	Aluminum Extrusion
<b>FINISH</b>	White
<b>WEIGHT</b>	4.80 lbs per foot
<b>MOUNTING</b>	Aircraft Cable
<b>LISTING</b>	Dry or Damp Location UL1598, CSA C22.2#250.0 UL8750, CSA250 UL2108, 67.1.9, 60.4, CSA C22.2 #9
<b>DRIVER</b>	Driver on Board or Remote Driver
<b>TEMPERATURE RATINGS</b>	Operating / Startup: $-20^{\circ}$ to $48^{\circ}\text{C}$ ( $-4^{\circ}$ to $120^{\circ}\text{F}$ ) Storage: $-40^{\circ}$ to $76^{\circ}\text{C}$ ( $-40^{\circ}$ to $170^{\circ}\text{F}$ )
<b>INSTALLATION LINKS</b>	<a href="#">Flange Ceiling Trim (FG)</a> <a href="#">T-Bar Ceiling Trim (TB)</a> <a href="#">T-Bar Return Ceiling Trim (TBR)</a> <a href="#">Hard Ceiling Trim (HC)</a> <a href="#">Mud-In Ceiling Trim (MI)</a>

## MOUNTING OPTIONS

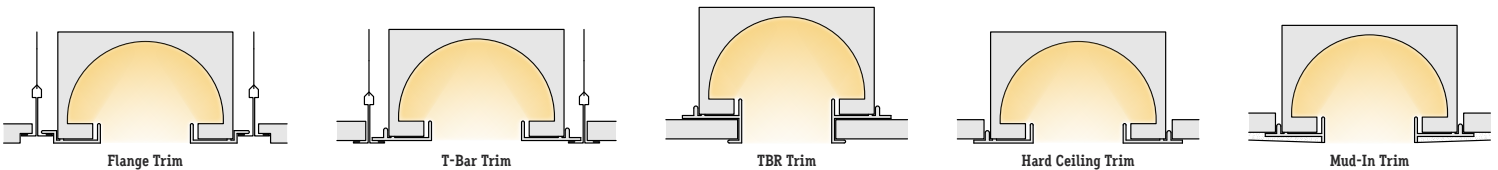

## SPECIFY PRODUCT CODE | CHOOSE FROM DROP DOWNS

SERIES	LED	CEILING TRIM	WATTS PER FOOT	DIMMING	LISTING	LUMINAIRE VOLTAGE <sup>*3</sup>	LUMINAIRE LENGTH
						DMX	
ALS500T-DBR	RGBW						
ALS500T-DBR (ALS500T-DBR)	Color Changing: Red, Green, Blue, White (RGBW)	Flange Ceiling Trim (FG)	2 Watts x 2 = 4 Watts (4W) 316 Lumens/ft <sup>*1</sup>	DMX-512 <sup>*2</sup> (DMX)	Indoor (DRY)	120 - 277 Volts Line Voltage (UNV)	Specify Length in Feet & Inches Example: 7'8"
		T-Bar Ceiling Trim (TB)	3 Watts x 2 = 6 Watts (6W) 474 Lumens/ft <sup>*1</sup>		Outdoor (DAMP)		
		T-Bar Return Ceiling Trim (TBR)	4 Watts x 2 = 8 Watts (8W) 632 Lumens/ft <sup>*1</sup>				
		Hard Ceiling Trim (HC)	5 Watts x 2 = 10 Watts (10W) 790 Lumens/ft <sup>*1</sup>				
		Mud-In Ceiling Trim (MI)	6 Watts x 2 = 12 Watts (12W) 948 Lumens/ft <sup>*1</sup>				

<sup>\*1</sup> Lumens per foot based on White Only at Full Output (100%). **Example:** 79 Lumens x 4 Watts = 316 Lumens per Foot

<sup>\*2</sup> Default DMX address of each fixture is 001. Consult third party DMX commissioner to modify at time of installation.

<sup>\*3</sup> Remote drivers wattage sized based on length of run. **Example:** 10' run x 6 watts per foot = 60 watts. Driver will be sized to 60 watts maximum.



CALIFORNIA  
ACCENT  
LIGHTING  
INC

# ALS500T-DBR-RGBW

## ELECTRICAL

DIMMING	DMX
MAXIMUM RUN (Class 2 Applications)	21' (4W), 14' (6W), 10' (8W), 8' (10W), 7' (12W)
LUMINAIRE VOLTAGE	120V - 277V (UNV)

## LAMP SPECIFICATIONS

LAMP NUMBER	DESCRIPTION	L70 LED LIFE
RGBW	Color Changing: Red, Green, Blue, White (3000K)	40,000 hours

## LAMP FEATURES

LAMP TYPE	High Output LEDs (No Mercury)
CRI	> 84 (Based on White @ Full Output)
EFFICACY	49 Lumens per Watt: All Colors @ Full Output (RGBW)
	35 Lumens per Watt: Red @ Full Output (R)
	50 Lumens per Watt: Green @ Full Output (G)
	28 Lumens per Watt: Blue @ Full Output (B)
	79 Lumens per Watt: White @ Full Output (W)

## DRIVERS

DIMMING SELECTION	PRODUCT CODE	LINK TO SPECIFICATION SHEET / URL
DMX-512	(DMX)	<a href="https://www.calilighting.com/assets/pdf/drivers/DRV100-E.pdf">https://www.calilighting.com/assets/pdf/drivers/DRV100-E.pdf</a>

## DMX CONTROLLERS (Sold Separately)



Color Wheel DMX Controller  
(DMX-1024C)

PART #	QTY.
DMX-1024C	

Note: Controls up to 1024 DMX Channels.



Standard DMX Controller  
(DMX-128C)

PART #	QTY.
DMX-128C	

Note: Controls up to 128 DMX Channels.

CALIFORNIA ACCENT LIGHTING, INC.

2820 E. Gretta Lane, Anaheim, CA 92806  
ph. 800.921.CALI (2254) | fx. 714.535.7902 | info@calilighting.com | calilighting.com

© CALI. All rights reserved. CALI reserves the right to make changes or withdraw specifications without prior notice.

alumLEDs™  
Manufactured in the U.S.A.

2 / 20 / 2024 / Rev 2

Page 2 of 5

## TRIM STYLE

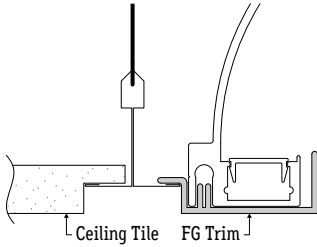

Flange Ceiling Trim  
(ALS500T-DBR-FG)

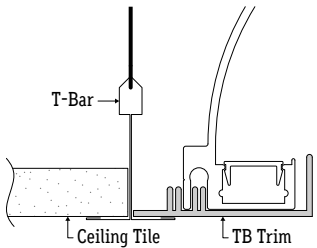

T-Bar Ceiling Trim  
(ALS500T-DBR-TB)

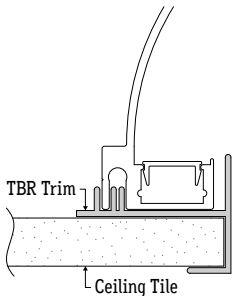

T-Bar Return Ceiling Trim  
(ALS500T-DBR-TBR)

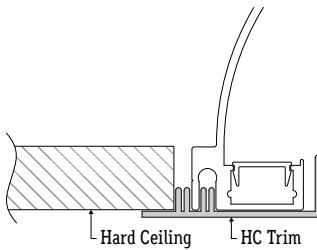

Hard Ceiling Trim  
(ALS500T-DBR-HC)

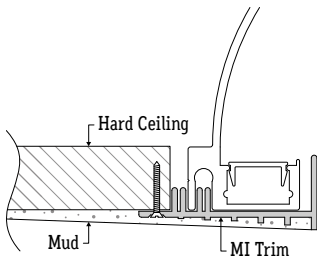

Mud-In Ceiling Trim  
(ALS500T-DBR-MI)

## DESCRIPTION

- Compatible with T-Bar ceiling grid systems
- Best used with tegular-edged tiles
- Trim rests on T-Bar grid

- Compatible with T-Bar ceiling grid systems
- Best used with square-edged tiles
- Trim rests on T-Bar grid

- Compatible with T-Bar ceiling grid systems
- Luminaire sits centered within the tile and spans a length shorter than the length of the tile.

- Compatible suspended hard ceiling systems
- Best used with drywall ceiling
- Trim is flush with ceiling surface

- Compatible suspended hard ceiling systems
- Best used with drywall ceiling
- Trim uses mud-in finish for seamless appearance

## FINISHED APPEARANCE

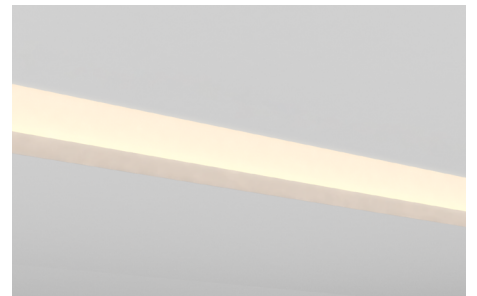
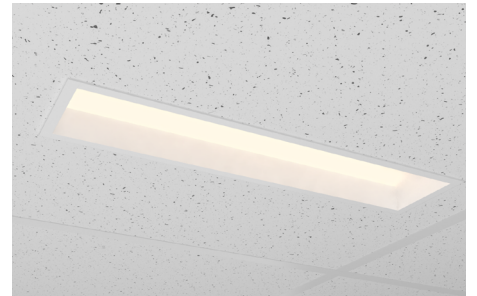
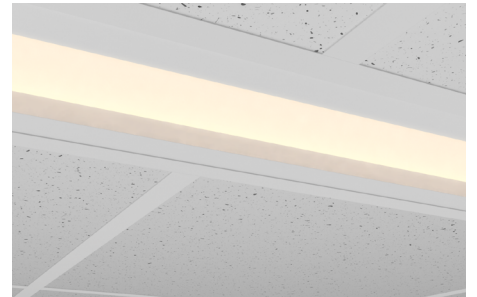
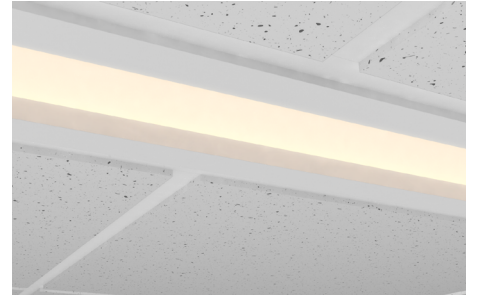

## MOUNTING ACCESSORIES (Sold Separately)

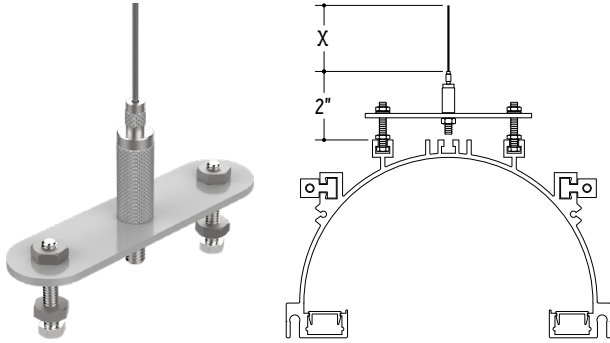

Aircraft Cable Assembly  
(ALS500T-DBR-AC-6')

PART #	QTY.
ALS500T-DBR-AC-6'	

**Note:** Use 3 Aircraft Cable Assemblies per 8', rounded up. Consult factory for custom cable lengths.

## ILLUMINATED CORNER (Sold Separately)

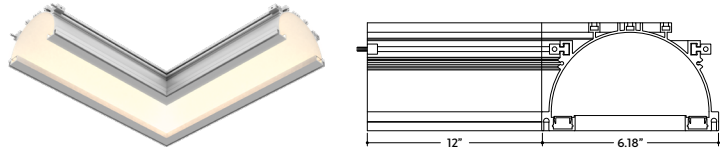

90° Illuminated Corner  
(ALS500T-DBR-RGBW-90D-X) X = Specify Product Code

SERIES	LED	CEILING TRIM	WATTS PER FOOT	DIMMING	LISTING	LUMINAIRE VOLTAGE**	QTY.
ALS500T-DBR	RGBW			DMX		UNV	

**Note:** Specify product code to match specified code from page 1.

## END CAPS & REFLECTIVE FILM (Sold Separately)

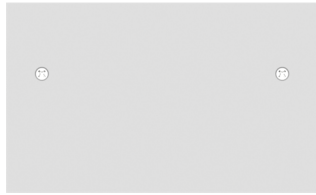

Standard End Cap  
(ALS500T-DBR-EC)

PART #	QTY.
ALS500T-DBR-EC	

**Note:** Use 1 Standard End Cap when the run terminates at a flat wall.

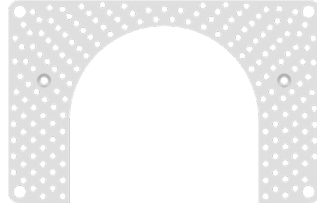

Mud-In End Cap with Round Opening  
(ALS500T-DBR-EC-RD)

PART #	QTY.
ALS500T-DBR-EC-RD	

**Note:** Use 1 Mud-In End Cap when the run will terminate with an opening.

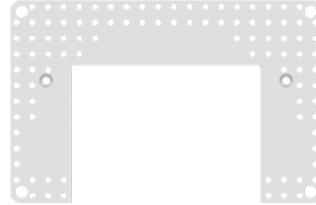

Mud-In End Cap with Square Opening  
(ALS500T-DBR-EC-SQ)

PART #	QTY.
ALS500T-DBR-EC-SQ	

**Note:** Use 1 Mud-In End Cap when the run will terminate with an opening.



Additional Reflective Film  
(ALS500T-DBR-RF-X)  
X = Specify Length Below

PART #	QTY.
ALS500T-DBR-RF-25'	
ALS500T-DBR-RF-50'	
ALS500T-DBR-RF-75'	
ALS500T-DBR-RF-100'	
ALS500T-DBR-RF-150'	
ALS500T-DBR-RF-200'	
ALS500T-DBR-RF-250'	

**Note:** Reflective Film is included with each run length. Use this accessory to order additional film if needed.

## DESIGN GUIDELINES

### Individual Run

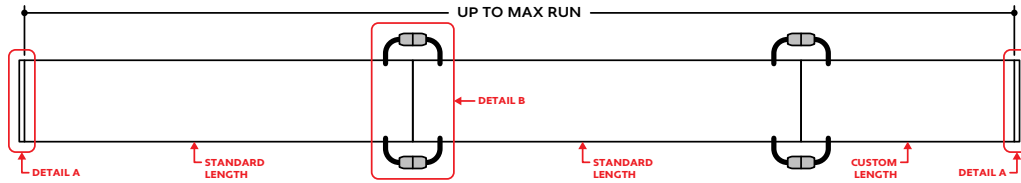

### Run with Mitered Corners

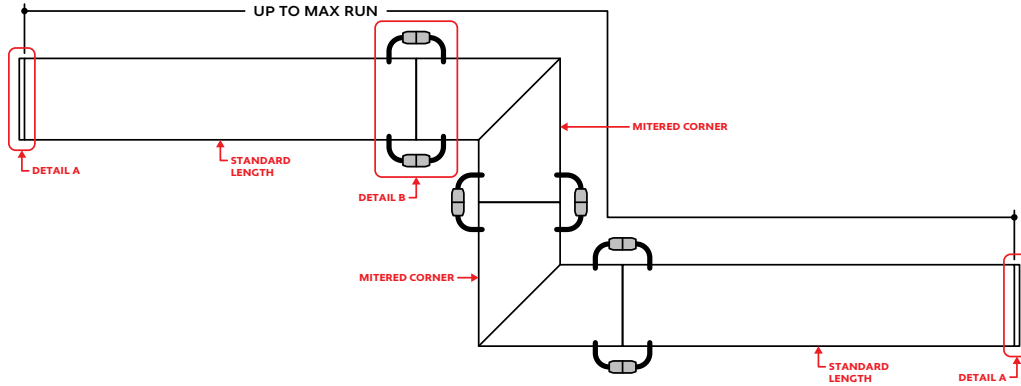

### Run with Jumper Cables

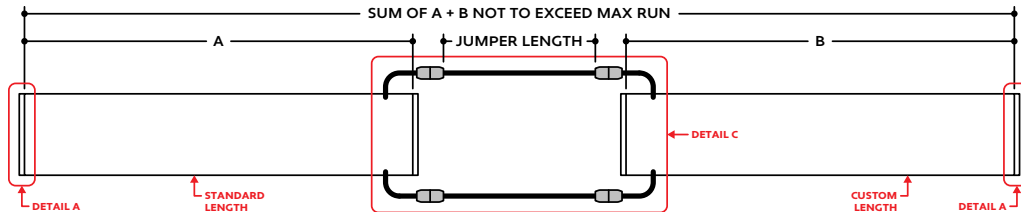

### Continuous Run Exceeding Maximum Run (2 Circuits)

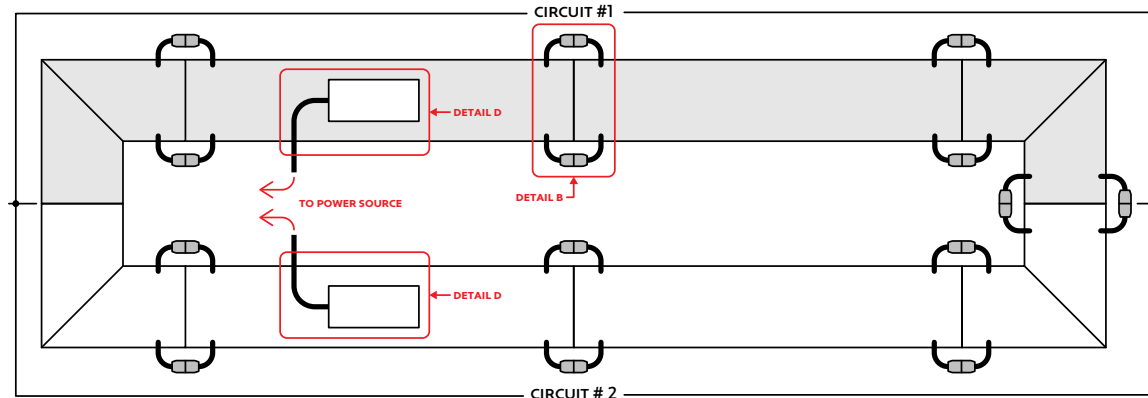

## KEY

- DETAIL A** **End Cap:** An end cap is used to terminate each run at either end.
- DETAIL B** **Continuous Connection:** Luminaire segments are connected using an included continuous connector. See installation instructions for details.
- DETAIL C** **Continuous Connector (Jumper):** Used to span a corner or traverse a gap, corner, or obstacle in the installation area.
- DETAIL D** **Remote Driver:** For T-Bar ceiling grid applications, the driver may be mounted on top of the luminaire. See installation instructions for details.

**Note:** Drawings not to scale. Product may differ from examples shown.

**CALIFORNIA ACCENT LIGHTING, INC.**

2820 E. Gretta Lane, Anaheim, CA 92806

ph. 800.921.CALI (2254) | fx. 714.535.7902 | info@calilighting.com | calilighting.com

© CALI. All rights reserved. CALI reserves the right to make changes or withdraw specifications without prior notice.

**alumLEDs**<sup>TM</sup>  
Manufactured in the U.S.A.

2 / 20 / 2024 / Rev 2

Page 5 of 5